

IP AUDIO INTERFACE**IP-A1AF**

Thank you for purchasing TOA's IP Audio Interface.
Please carefully follow the instructions in this manual to ensure long, trouble-free use of your equipment.

TABLE OF CONTENTS

1. SAFETY PRECAUTIONS	2
2. SUMMARY AND FEATURES	4
3. ABOUT SECURITY MEASURES	4
4. SYSTEM EXAMPLE	5
4.1. SIP Broadcasting/Two-way Communication	5
4.2. VMS Broadcasting	5
4.3. Local Broadcasting	5
5. DIMENSIONAL DRAWINGS	6
6. NOMENCLATURE AND FUNCTIONS	7
7. HANDLING PRECAUTIONS	8
8. UNIT MOUNTING	9
9. CONNECTIONS	9
9.1. Network Connection	9
9.2. Connections to LINE/MIC Input and Line Output Terminals	10
9.3. Connections to Control Input and Output Terminals	11
9.4. Removable Terminal Plug Connections	12
10. SETTINGS	13
10.1. System Settings Summary	13
10.2. System Requirements	14
10.3. Connection with Browser	14
11. INITIALIZATION OF SETTINGS	15
12. CAUTIONS REGARDING THE AVC/H.264 PATENT LICENSE	16
13. OPEN SOURCE SOFTWARE	16
14. ACCESSORIES	16

1. SAFETY PRECAUTIONS

- Before installation or use, be sure to carefully read all the instructions in this section for correct and safe operation.
- Be sure to follow all the precautionary instructions in this section, which contain important warnings and/or cautions regarding safety.
- After reading, keep this manual handy for future reference.



WARNING

Indicates a potentially hazardous situation which, if mishandled, could result in death or serious personal injury.



CAUTION

Indicates a potentially hazardous situation which, if mishandled, could result in moderate or minor personal injury, and/or property damage.



WARNING

When Installing the Unit

- Do not expose the unit to rain or an environment where it may be splashed by water or other liquids, as doing so may result in fire or electric shock.

When the Unit is in Use

- Should the following irregularity be found during use, immediately cut off the power supply from a PoE+ or PoE switching hub and contact your nearest TOA dealer. Make no further attempt to operate the speaker in this condition as this may cause fire or electric shock.
 - If you detect smoke or a strange smell coming from the unit
 - If water or any metallic object gets into the unit
 - If the unit falls, or the unit case breaks
 - If the LAN cable is damaged (exposure of the core, disconnection, etc.)
 - If the speaker suddenly stops producing sound
- To prevent a fire or electric shock, never open nor remove the unit case as there are high voltage components inside the unit. Refer all servicing to qualified service personnel.

- Do not touch the unit and LAN cable during thunder and lightning, as this may result in electric shock.

- To prevent the electromagnetic wave from badly influencing medical equipment, make sure to switch off the unit's power when placing it in close proximity to the medical equipment.



CAUTION

When Installing the Unit

- Avoid installing the unit in humid or dusty locations, in locations exposed to the direct sunlight, near the heaters, or in locations generating sooty smoke or steam as doing otherwise may result in fire or electric shock.
- Avoid touching the unit's sharp metal edge to prevent injury.



The IP-A1AF IP audio interface is capable of delivering extremely high volume sound output. Therefore, close proximity to the unit over time could present the danger of hearing impairment. Be sure to follow the instructions below when conducting performance tests:

- Turn down the sound volume before adjusting the volume.
- Do not position one's ear close to the speaker.
- Point the unit in a direction where no people are present.
- Avoid listening to high-volume output for prolonged periods of time.

FCC REQUIREMENTS

Note

This equipment has been tested and found to comply with the limits for a Class A digital device, pursuant to Part 15 of the FCC Rules. These limits are designed to provide reasonable protection against harmful interference when the equipment is operated in a commercial environment. This equipment generates, uses, and can radiate radio frequency energy and, if not installed and used in accordance with the instruction manual, may cause harmful interference to radio communications.

Operation of this equipment in a residential area is likely to cause harmful interference in which case the user will be required to correct the interference at his own expense.

Modifications

Any modifications made to this device that are not approved by TOA Corporation may void the authority granted to the user by the FCC to operate this equipment.

Warning: Operation of this equipment in a residential environment could cause radio interference.

This equipment is not suitable for use in locations where children may be present.

2. SUMMARY AND FEATURES

The IP-A1AF is an IP Audio Interface which decodes IP audio streams into analog signals. It is equipped with a built-in 15 W amplifier to drive Low-impedance speaker(s). Analog audio and control outputs can be connected to an external amplifier for scaling up the system capability.

- Power is supplied by way of PoE+ (IEEE 802.3at) or PoE (IEEE 802.3af) switching hubs.
- The IP audio interface is compatible with the following broadcasting modes:

Internal sound source broadcasting mode	Enables broadcast of up to 20 internal sound source files by means of control input or Remote API (HTTP).
VMS broadcasting mode	Enables backchannel audio broadcast from the VMS (Video management system) software using the common protocol for IP cameras.
SIP broadcasting mode	Enables SIP broadcasts from any voice communications device that utilizes the SIP protocol, such as SIP or IP telephone (IP-PBX) systems.
Multicast broadcasting mode	Allows up to 20 multicast ports to be set up, for 20 multicast audio stream paging groups.
Local broadcasting mode	Local broadcasting mode enables broadcast locally to the speaker output and the LINE output from the sound source device or microphone connected with LINE/MIC input.

- Orders of priority can be set among the various broadcasting modes, meaning higher priority broadcasts can interrupt and override lower priority broadcasts.
- Since the unit is equipped with individual offset adjustable volumes for each broadcasting modes and patterns (internal sound source), actual broadcasting volume can be normalized or optimized.
- Broadcasts can be controlled using Remote API or control inputs from connected external equipment.
- Connected external equipment can be controlled by control outputs in synchronization with speaker broadcasts.

3. ABOUT SECURITY MEASURES

- Ensure that sufficient security measures are taken on the customer's own responsibility.
- TOA Corporation takes no responsibility for damage or loss caused by security-related problems, such as illegal access.
- To help prevent illegal access to the unit, be sure to change the user ID and password from those used for initial setup. For setting methods and other details, please refer to the separate setup manual which can be downloaded from the TOA DATA Library (<https://www.toa-products.com/international/>).
- Take utmost care in the management of the unit's communications password.

4. SYSTEM EXAMPLE

4.1. SIP Broadcasting/Two-way Communication

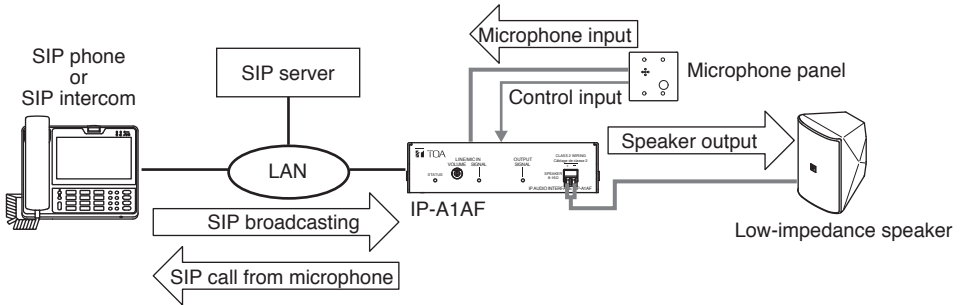

Tips

- Set the local broadcasting settings "OFF." If it is "ON," the microphone input voice will be output to the speaker.
- When the voice switch setting is "ON," the call will be half-duplex.

4.2. VMS Broadcasting

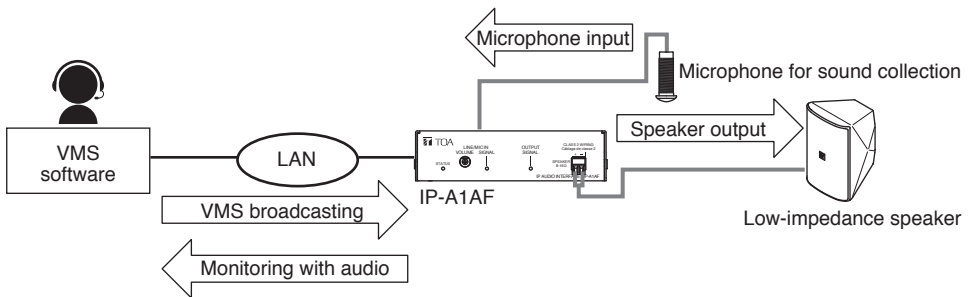

Tip

Set the local broadcasting settings "OFF." If it is "ON," the microphone input sound will be output to the speaker.

4.3. Local Broadcasting

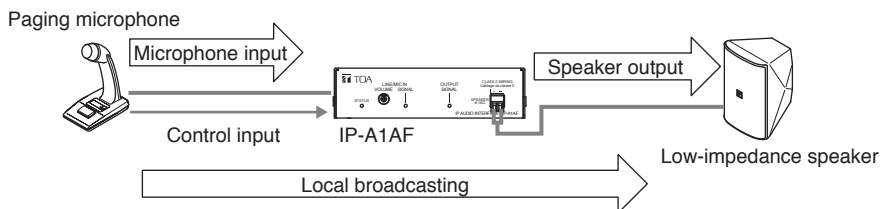

Tip

Set the local broadcasting settings "ON."

5. DIMENSIONAL DRAWINGS

Unit: mm (in)

[Front]

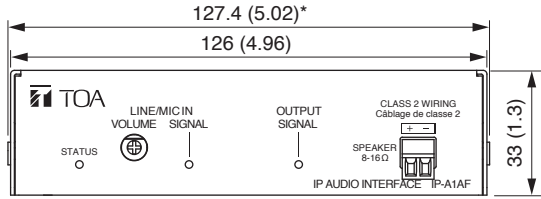

[Bottom]

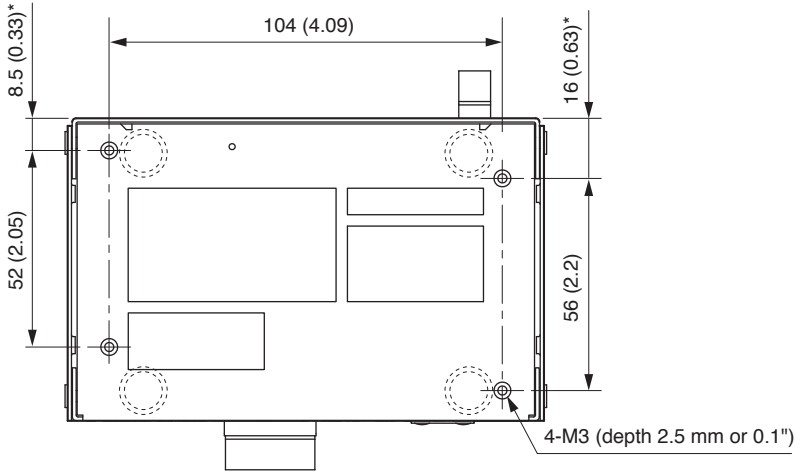

[Side]

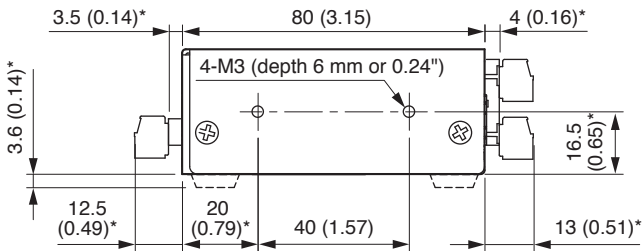

* Reference dimension

6. NOMENCLATURE AND FUNCTIONS

[Front]

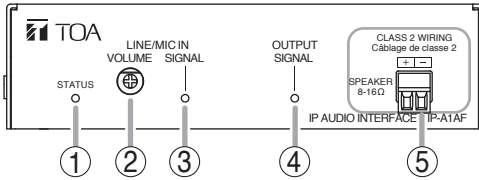

[Bottom]

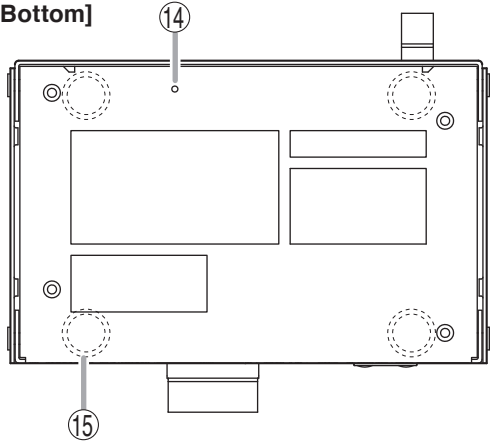

[Rear]

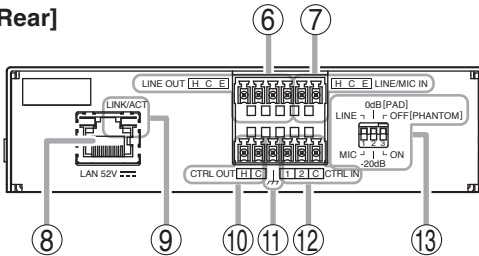

The figure with a removable terminal plug detached.

- 1. Status indicator (green, blue, yellow, red)**
Indicates the unit's operating status.

Unit Operation	Status Indicator
System startup	Flashing green
Broadcast standby	Continuously lit green
Broadcasting	Continuously lit blue
System mute*	Flashing red
Initialization or firmware updating	Continuously lit yellow

* System mute is a state in which this unit is muted by the control from the transmitting device.

- 2. LINE/MIC input volume control**
Adjusts the volume level of the LINE/MIC input. Rotate this volume control clockwise to increase the volume level and counterclockwise to decrease it. Set this volume not to make the LINE/MIC input signal indicator (3) light up in red.
- 3. LINE/MIC input signal indicator (green, red)**
Lights green when a signal is input to LINE/MIC input. Lights red when the input signal level is too high.

- 4. Output signal indicator (green)**
Lights green when a signal is outputting from the speaker or line output.

- 5. Speaker output terminal (8 – 16 Ω)**
Connects only with low-impedance speakers.
Tip
Amplifier rated output is as follows.
• 8 W at PoE powered, 8 Ω
• 15 W at PoE+ powered, 8 Ω

- 6. Line output terminal**
Connects with an external amplifier etc. and outputs the same audio as the speaker output.

- 7. LINE/MIC input terminal**
Connects with a microphone or sound source device.
This can also be used as an analog audio input when in local broadcasting mode or alternatively as an audio input during SIP calls, or for monitoring VMS broadcast. Adjust with the DIP switch according to the output level of the connected device.

- 8. LAN port**
Connect to a PoE+ or PoE switching hub using a LAN cable.

9. LINK/ACT indicator (green)

Flashes when data is being sent or received over a network.

10. Control output terminal

Allows control of external equipment in synchronization with the unit operation.

11. Functional ground terminals

If excessive noise is produced when the speaker is connected to external equipment, connect this terminal to the external equipment's functional ground terminal, potentially minimizing the noise level.

Note

This terminal is not for protective ground.

12. Control input terminals

Allows input of control signals from connected external equipment to enable actions set in the Event settings.

13. DIP switch

• LINE/MIC switch (Switch 1)

Set this switch to MIC when connecting a microphone, and to LINE when connecting a general sound source device other than a microphone.

Default setting: LINE

• PAD switch (Switch 2)

Enables or disables the MIC input pad. When the input level is high, set the PAD to -20 dB.

Default setting: 0 dB

• PHANTOM switch (Switch 3)

Set whether or not to supply phantom power to the microphone connected to MIC IN. Phantom power is a 12 V DC.

Default setting: OFF

14. Reset key

The unit begins to restart when this key is clicked.

Hold down this key until the Status indicator (1) lights yellow to initialize the unit's settings.

15. Rubber feet attachment position

7. HANDLING PRECAUTIONS

- Please apply the latest firmware version to this product. The latest version is available at the TOA DATA Library (<https://www.toa-products.com/international/>).
- As this product is IP-based, a slight time lag between actual and broadcast may happen.
- Broadcast audio may sometimes break up due to packet loss or network failure.
- Periodic inspection and manual rebooting are needed to extend the product life.
- This product may reboot automatically to keep the stable operation.

8. UNIT MOUNTING

It is recommended to install it as shown in the example blow.

[Putting on the desk]

It can be used on a desktop by attaching the accessory rubber foot to the bottom of this unit.

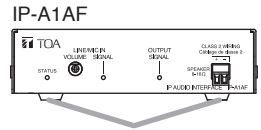

Rubber foot (accessory)

[Mounting on the wall]

Prepare a commercially available L-shaped bracket, etc., and fix it with the accessory screws using the four screw holes of this unit.

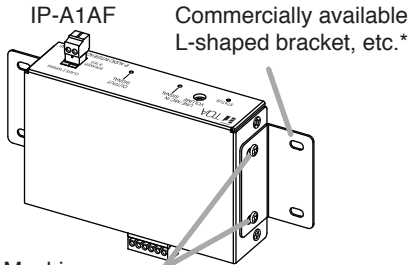

Machine screw

M3 x 6 (accessory) * Plate thickness 1 to 3 mm (0.04" to 0.12")

Commercially available L-shaped bracket, etc.*

IP-A1AF

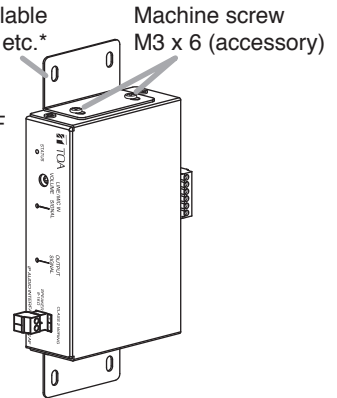

Machine screw M3 x 6 (accessory)

Note

Use metal fittings of sufficient strength and install in a place with sufficient strength.

9. CONNECTIONS

9.1. Network Connection

Connect the IP-A1AF to the PoE+ or PoE switching hub using a LAN cable (straight UTP or STP cable, both rated at Category 5e or greater and fitted with RJ45 connectors). Power is supplied by the PoE+ or PoE switching hub.

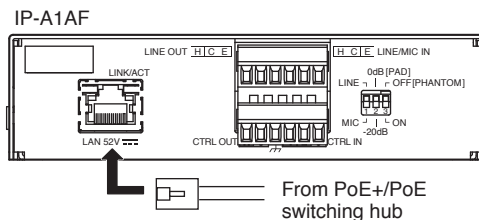

From PoE+/PoE switching hub

Compatible switching hubs: Switching hubs conforming to PoE+ (IEEE802.3at Class 4) or PoE (IEEE802.3af Class 3) specifications

9.2. Connections to LINE/MIC Input and Line Output Terminals

Use the supplied removable terminal plugs (6 pins) for connection. Use a 2-core shielded cable to connect the audio device.

For connection of the removable terminal plugs, see "Removable Terminal Plug Connections" on p. 12.

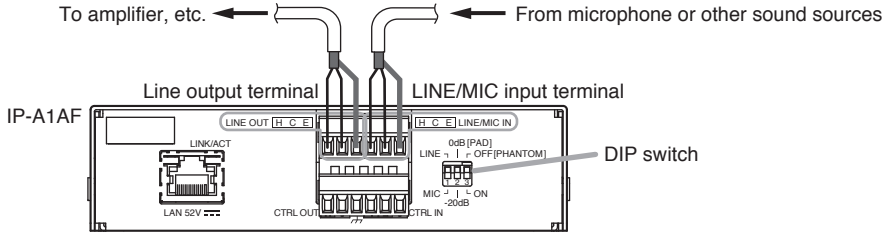
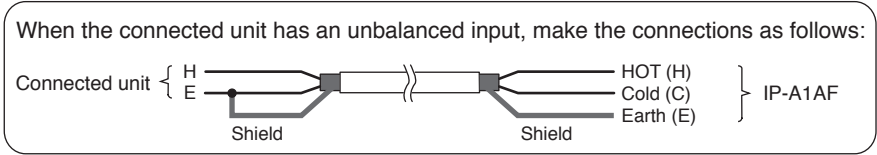

Set the DIP switch according to the audio device to be connected.

[DIP switch settings]

Input device	DIP switch settings
Line level sound source	1: LINE 2: 0 dB [PAD] 3: OFF [PHANTOM] (Default settings)
Dynamic microphone	1: MIC 2: 0 dB [PAD] 3: OFF [PHANTOM]
Electret condenser microphone	1: MIC 2: -20 dB [PAD] 3: ON [PHANTOM]

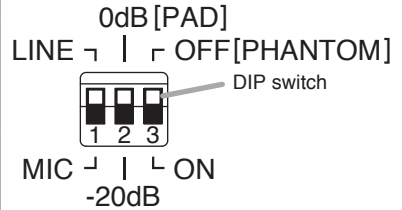

Note
Please change DIP switch settings while the power is off.

[LINE/MIC input level adjustment]

Set roughly the volume of individual connected devices by DIP switch. After that, use the LINE/MIC input volume control for fine volume adjustments.

Adjust the level so that the LINE/MIC input signal indicator lights green, not red.

Note

Rotate the input volume control screw using an appropriate screwdriver. When rotating, do not press on the screwdriver with too much force, so as to avoid damage to the adjuster.

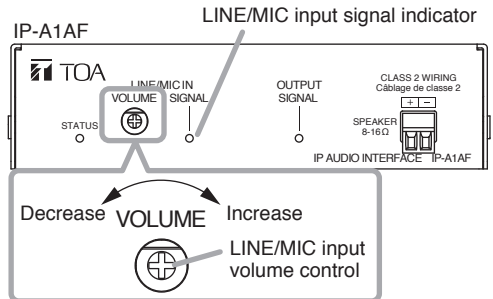

9.3. Connections to Control Input and Output Terminals

Use the supplied removable terminal plugs (6 pins) for connection. Connect a control line of 2 channels control input and 1 channel control output from the external control device to the unit's control input or control output terminal. For connection of the removable terminal plugs, see "Removable Terminal Plug Connections" on p. 12.

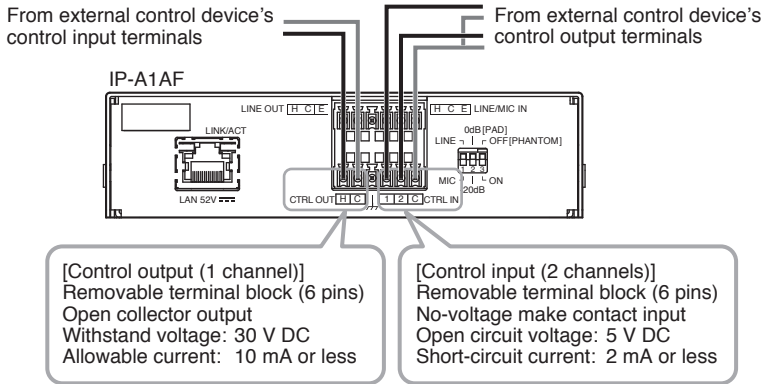

The figure with a removable terminal plug detached.

The following functions can be assigned to the control input and control output terminals by browser settings:

Terminals	Assignable Functions
Control input terminals	<ul style="list-style-type: none"> • SIP device calls • Internal sound source broadcasts • Local broadcasting • Change the speaker volume (Mute or volume offset)
Control output terminals	<ul style="list-style-type: none"> • SIP broadcast in progress output • VMS broadcast in progress output • Multicast broadcast in progress output • Internal sound source broadcast in progress output • Local broadcasting in progress output

For settings, please refer to the separate setup manual.

The latest version of the setup manual is available on the TOA DATA Library (<https://www.toa-products.com/international/>).

9.4. Removable Terminal Plug Connections

Please note the following points when making connections to the control input, control output, and speaker output terminals using the supplied removable terminal plugs:

- Do not tin stripped wire ends with solder. Soldered wire ends will be crushed when the terminal plug screws are tightened, leading to higher contact resistance and potentially resulting in an abnormal rise in the temperature of the connected parts.
- Use AWG 28 – 22 wire ($\varnothing 0.32 - 0.64$ mm solid wire or multi-stranded wire with a cross-sectional area of $0.08 - 0.32$ mm²).
- Strip the wire end back about 7 mm (0.28").
- When connecting 2 wires or a signal cable to a single terminal, crimp them in an insulated (twin) wire ferrule to prevent their core wires from being separated from one another. Use a ferrule of the dimensions shown in the figure at right.

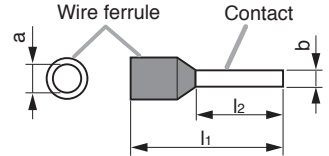

b: 0.8 – 1.1 mm (0.03" – 0.04")
l₂: 8 mm (0.31")

Note

Select dimensions "a" and "l₁" depending on the wires to be used.

[Plug Connection Procedure]

Step 1. Remove the plug from the terminal.

Step 2. Loosen the terminal screw and insert a wire.

Step 3. Tighten the screw firmly.

Note

Pull on the wire to ensure that it does not come off.

Step 4. Insert the plug into the terminal.

Tip

Recommended slotted screwdriver is as follows.
Blade width: about 2.5 mm (0.1")

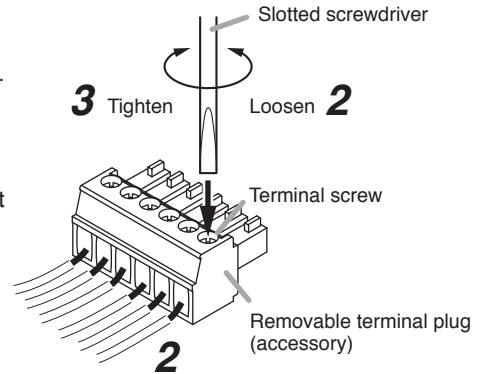

Shape of bit
2.5 mm (0.1")



10. SETTINGS

10.1. System Settings Summary

The following settings can be performed using a PC browser connected to the same network as the IP audio interface.

Setting Name	Setting Item
Status	Confirmation of current firmware version, network settings, volume setting
Network	Network settings such as the IP address
SIP	Settings of SIP connection enable/disable, SIP server address, authentication information, and audio codec
VMS Broadcasting	Settings of VMS connection enable/disable and authentication information, connection port settings
Multicast	Settings of multicast reception enable/disable, multicast address and port, and control output during multicast broadcast
Local Broadcasting	Settings of local broadcasting function enable/disable. Tip When the local broadcasting function is enable, the audio (SIP call and VMS monitoring audio) from this unit to network is muted.
Audio	Settings of speaker volume, input volume for individual broadcast classifications, and the sensitivity of LINE/MIC input for SIP and VMS broadcasting
Media	Uploading/downloading or deletion of sound source files such as messages to or from the internal memory
Pattern	Registration of sound source playback to be associated with events as patterns
Event	Settings of operations to be synchronized with the control input and control output
Priority	Settings of priority order for each broadcast mode; SIP broadcast, VMS broadcast, multicast broadcast and internal sound source broadcast
User	Changing username and password
Maintenance	Download and upload the configuration file, initialization, firmware update, hardware reboot, and downloading action logs
System	Date and time settings, NTP server settings, Time zone settings

For more information, please refer to the separate setup manual.

The latest version of the setup manual is available on the TOA DATA Library (<https://www.toa-products.com/international/>).

10.2. System Requirements

Connectable system requirements are as follows:

Display	Resolution: 1366 × 768 or greater
OS	Windows 10 Pro (64-bit), Windows 10 Home (64-bit), Windows 11 Pro, Windows 11 Home
Browser	Microsoft Edge, Google Chrome

Notes

- Windows and Microsoft Edge are registered trademarks of Microsoft Corporation of the United States in the United States and other countries.
- Google Chrome is a trademark of Google LLC of the United States in the United States and other countries.

10.3. Connection with Browser

10.3.1. Connection presets

The IP audio interface is factory-preset as follows:

Username: admin
Password: guest
IP address: 192.168.14.1
Subnet mask: 255.255.255.0
Default gateway: 0.0.0.0

Before connecting a PC to the IP audio interface and changing its setting, it will be necessary to set the PC's network settings so that it can operate on the same network as the IP audio interface. Take care that no IP addresses are duplicated in the same network.

For example, if the IP audio interface's IP address is 192.168.14.1, set the PC's IP address to 192.168.14.10.

10.3.2. Making connection

Notes

- Avoid simultaneously connecting to the IP audio interface from multiple PCs.
- Avoid simultaneously connecting to the IP audio interface from a single PC using multiple browsers.

Step 1. Start the browser and enter the speaker's IP address in the address field.
The Login screen is displayed.

Step 2. Enter the username and password, and click the LOGIN button.
The Status screen is displayed, enabling a range of settings.

Note

For details regarding the setting method, please refer to the separate setup manual.

The latest version of the setup manual is available on the TOA DATA Library (<https://www.toa-products.com/international/>).

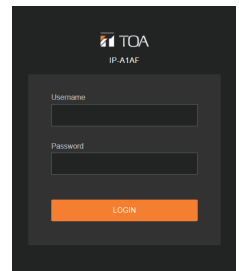

11. INITIALIZATION OF SETTINGS

Follow the procedure below to return all unit settings to their default:

Tip

When initialized with the reset key, the unit's sound source files are left in "Media," not deleted. Initialization to factory defaults, including deletion of sound source files, should be performed using the browser settings menu.

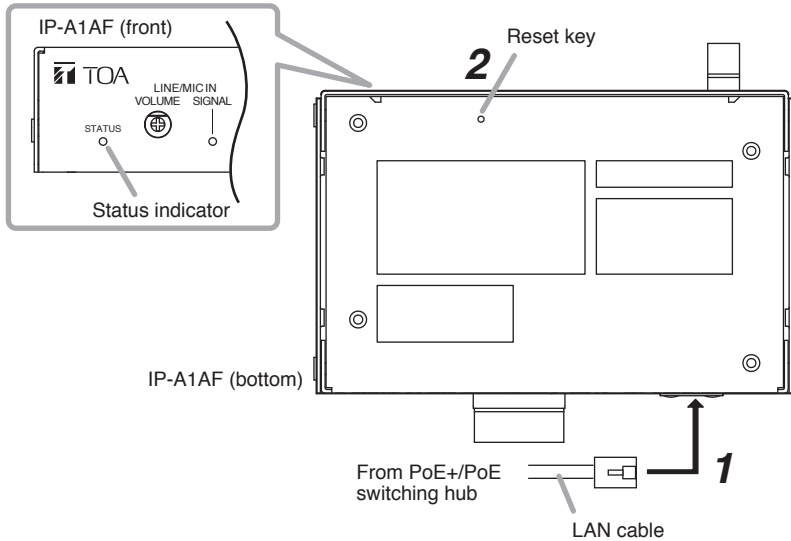

Step 1. Connect the speaker to the PoE+ or PoE switching hub using a LAN cable. The speaker will be started.

Step 2. Hold down the reset key located on the bottom panel using a pointed tool. The speaker automatically restarts and settings initialization begins.

Tip

Clicking on the reset key causes the unit to be restarted.

If pressure on the reset key is released part way through the initialization process, only unit restart will be performed, and the settings will not be initialized.

To click on the reset key, use a tool that is thinner than $\varnothing 1.5$ mm (0.06") and longer than 5 mm (0.2").

Step 3. When the status indicator lights yellow, release the reset key.

When initialization is complete, the status indicator lights green and all settings will be initialized to their default settings.

[Default Settings]

Username: admin
Password: guest
IP address: 192.168.14.1
Subnet mask: 255.255.255.0
Default gateway: 0.0.0.0

12. CAUTIONS REGARDING THE AVC/H.264 PATENT LICENSE

TOA's IP-A1AF IP audio interface employs MPEG technology (AVC/H.264 Standard) regarding the handling of image information. TOA Corporation has received approval to use this technology from MPEG LA, LLC, the patent management group.

Please note that the use of this product is prohibited except the following cases:

The use of the product is intended for personal use of a user of the MPEG technology and also for non-profit use, which includes (i) video encoding conforming to the AVC/H.264 Standard (hereinafter referred to as "AVC/H.264") and/or (ii) personal use and decoding of AVC/H.264 encoded by an MPEG technology user engaged in non-profit activities and/or AVC/H.264 furnished by a video provider who is granted a license by MPEG LA, LLC.

Regarding use for sales promotion or commercial purposes, or additional licensing information, please contact MPEG LA, LLC (<https://www.mpegla.com>).

13. OPEN SOURCE SOFTWARE

This product uses software based on open source software license(s).

If you need further information about the original open source software including source code, please download it from the TOA DATA Library (<https://www.toa-products.com/international/>).

Please note that we cannot answer any questions about the contents of the original source code.

This product includes software developed by the OpenSSL Project for use in the OpenSSL Toolkit (<http://www.openssl.org/>).

This product includes cryptographic software written by Eric Young (eyay@cryptsoft.com).

14. ACCESSORIES

Removable terminal plug (6 pins, preinstalled on the unit)	2
Removable terminal plug (2 pins, preinstalled on the unit)	1
Rubber foot	4
Machine screw M3 x 6	4

Tip

The specifications of this product are available in TOA DATA Library (<https://www.toa-products.com/international/>).

Scan the QR Code at right with your mobile phone camera to access the WEB site and search for this product number (IP-A1AF).



Note: "QR Code" is a registered trademark of DENSO WAVE INCORPORATED.

Traceability Information for USA

Manufacturer:
TOA Corporation
7-2-1, Minatojima-Nakamachi, Chuo-ku, Kobe, Hyogo,
Japan

Authorized representative:
TOA Electronics, Inc.
1 Harmon Plaza, Suite 700 Secaucus,
New Jersey 07094,
USA